

Medical

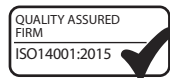

MP-500 The MP Range is purpose built for clean efficient waste destruction.
 The MP range is specially designed for safely incinerating hazardous high moisture biological red bag waste.



The MP-500 is the largest of the MP range of medical waste incinerators. Securely destroying a complete range of Medical, Pathological and Clinical waste.

Designed and built along the latest advances in medical incineration. Benefiting from Hot Hearth technology, efficiently recycling heat throughout and below the primary chamber, delivering complete 360° heating.

Unrivalled in it's field boasting a 40% reduction in fuel consumption compared to alternative solutions. The MP-500 is ideally suited for facilities of between 625-1000 beds and equivalent.

Machine Specification	
External L x W x H (mm)	3440 x 1150 x 2100
Internal L x W x H (mm)	2400 x 700 x 700
Chamber Volume (m³)	1.2
Weight (approx tonnes)	6.4
Max Load Capacity (kg)	500
Nominal Burn Rate UK* (kg/hr)	<50
Burn Rate [Export Only]* (kg/hr)	50 - 75
Thermal Capacity (kW)	480
Power Supply 50/60 hz	210/230v
Door Aperture	2400 x 700
Hot Hearth Principle	Double Pass
Fuel Types	Diesel, LPG, N-Gas
Control Panel	AI or PLC
Insulation Board	25mm Super-wool
Insulation Fire Brick	Grade E23
Fire Brick (Alumina)	42.5%

*We reserve the right to change the specification, dimensions and quality of materials from time to time, so long as the alteration is minor or an improvement to the said product.

Primary Chamber

- Heavily insulated internal refractory lining. Constructed from high grade refractory brick ensuring a secure self supporting, interlocking arrangement.
- Manually opening, securely locking, access door with viewing port.
- Automatic temperature controlled on-off waste ignition burner complete with internal air fans.
- Hot Hearth Combustion Burner, temperature controlled on-off, complete with internal air fans.
- Secondary combustion burner air fans, automatically controlled distribution to their designated area.
- Two temperature sensor mounting points.

Secondary Chamber

- Fully insulated internal refractory lining. Constructed from high grade refractory brick and low thermal mass insulation.
- Secondary chamber burnout burner, temperature controlled on-off complete with internal air fans
- Automatically controlled integrated combustion burner air fans.
- Temperature sensor mounting point at the base of the exit flue ensuring the chamber reaches the necessary 1100°C minimum

Waste Type

	Clinical Waste	✓
	Treated Waste	✓
	Anatomical Waste	✓
	Cytotoxic & Cytostatic Waste	✓
	Offensive/Hygiene Waste	✓
	Medicinal Waste	✓
	Domestic (municipal) Waste	✓

Medical

MP-500

The MP Range is purpose built for clean efficient waste destruction.



Waste Loading and De-Ashing

The MP series of incinerators are ergonomically designed for easy and safe loading of all medical waste streams. Loading through the front facing door can be completed manually or with the aid of a hydraulic lifting table. The MP machines can be loaded multiple times throughout a cycle. At the end of every incineration process, ash should be discharged through the loading door onto the supplied catcher tray prior to being loaded for the next burn.

The Addfield Difference

- Pre-Fabricated 8mm & 10mm robust mild steel casing, seam welded and suitably stiffened/ braced where necessary.
- Lightweight resilient refractory fibre insulation door, providing a tight seal, giving excellent thermal efficiency.
- Primary and secondary chamber lining thickness 220mm rated at 1650°C.
- Premium paint finish - Steel structures are painted using a two-pack high grade paint system.
- Unique Hot Hearth technology enabling increased efficiency of incineration by providing additional heating below the chamber encouraging 360° heat distribution.
- Multi-layered refractory lining using fire bricks and insulation bricks, improving thermal efficiency.



Additional Operation Equipment



Bin Tipper

The safest way to load hazardous waste directly into top loading ram loaders. Hands free operation for up to 150kg, compatible with the majority of waste bins. Reliable hydraulically operated mechanism.



Ram Loader

Built to enable the option of continuous loading throughout operation. Securely positioning waste into the primary chamber whilst maintaining temperature and preventing radiant heat and thermal



Venturi System

An advanced flue gas treatment system designed to further reduce dust, acid gasses, dioxins and furans. Highly effective the venturi is widely regarded as the leading treatment system in its field.

MP-500

IF IN DOUBT PLEASE ASK

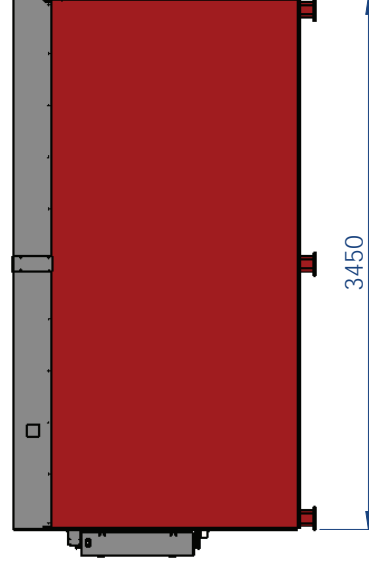
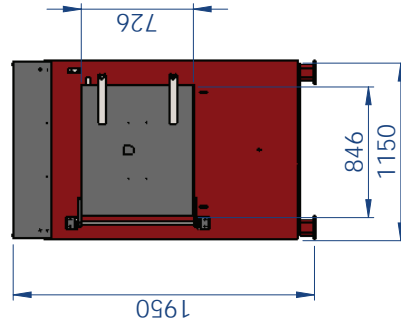
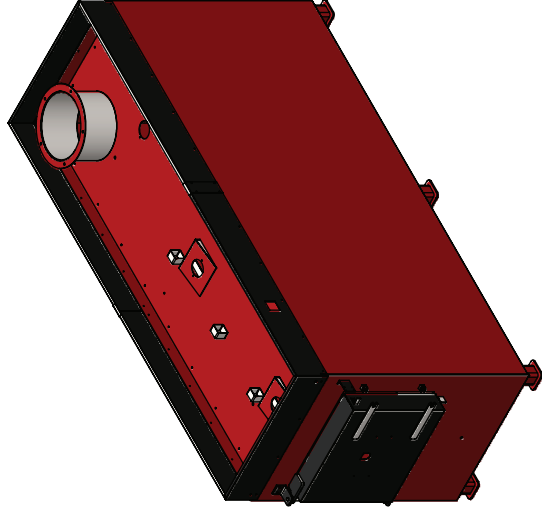
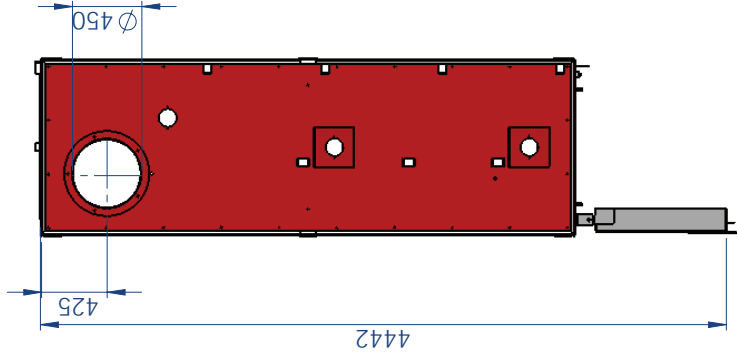

Material:

Specification:

Finish:

Scale: 1:35

Drawn by:
A Singh

Approved by:

Last saved
date: 09/07/2018

Weight: kg

Notes:

Dimensions in Millimeters

addfield
Incinerate • Cremate

Unit 9, Zone 4
Burntwood
Business Park,
WS7 3XD

06 July 2018 15:53:31

Tolerances, Unless otherwise stated

WHOLE NUMBERS ± 1.00
1 DECIMAL PLACE ± 0.10
2 DECIMAL PLACE ± 0.05
ANGLES ± 0.5°

Maximum Surface Finish
Unless otherwise stated 3.2/√

Title: MP500 Assembly

A3

REV. 0

Drawing
Number: MP500-GA

1

1

Controller



Addfield Intelligent Controller

Simple to operate adaptive control system for achieving optimal results from your machine.

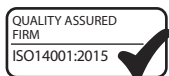
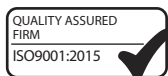

Controller Features

The Addfield Intelligent Controller has been developed to provide you with a simple yet effective operational process. Designed around a touch screen HMI interface, and independent burner control switches.

The touch screen interface provides all of your essential operations at the press of a finger. Having pre-loaded programmes optimised for your individual requirements, waste type and operating regime.

Giving you instant access to live temperature readings for the primary and secondary chambers and remaining burn time to enable you to manage your incineration process more efficiently.

Simple to install with a plug and play interface which enables straight forward installation and maintenance.

Built in data-logging to automatically records you usage, timings and temperatures achieved. Archives all essential which is able to be exported to Excel through the removable USB drive.



Key Features

- Plug and play design
- Zone ramp sequence multi zone controller.
- Incoming and outgoing cable terminations.
- Burner control gear.
- Interface relays and contractors.
- Temperature indication and control of the primary chamber.
- Temperature indication and control of the secondary chamber.
- Plant status indicators.
- Cycle status indicators.
- Fault status indicators.
- Operator interface.
- Data-logging
- USB Port.

*We reserve the right to change the specification, dimensions and quality of materials from time to time, so long as the alteration is minor or an improvement to the said product.